

INSTALLATION SHEET

CLASSIC
PLATINUM & BLACKMAX™

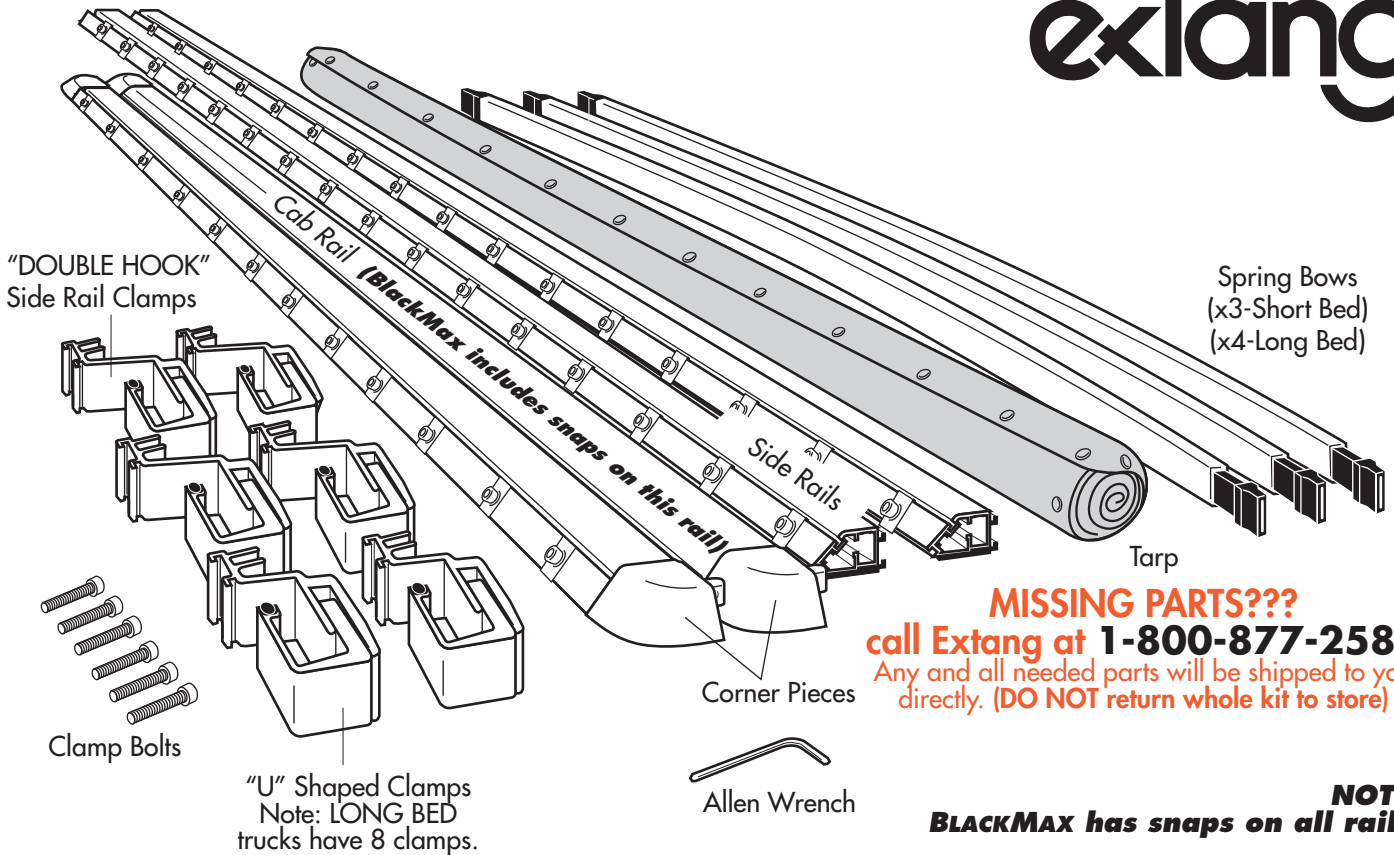

MISSING PARTS???
call Extang at **1-800-877-2588**
Any and all needed parts will be shipped to you directly. (DO NOT return whole kit to store)

NOTE:
BLACKMAX has snaps on all rails.

PARTS INCLUDED IN YOUR KIT. You may want to lay them out in this manner for accessibility.

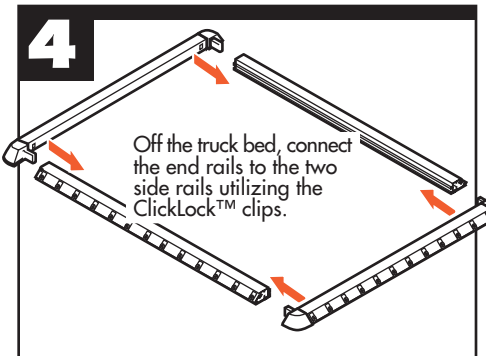
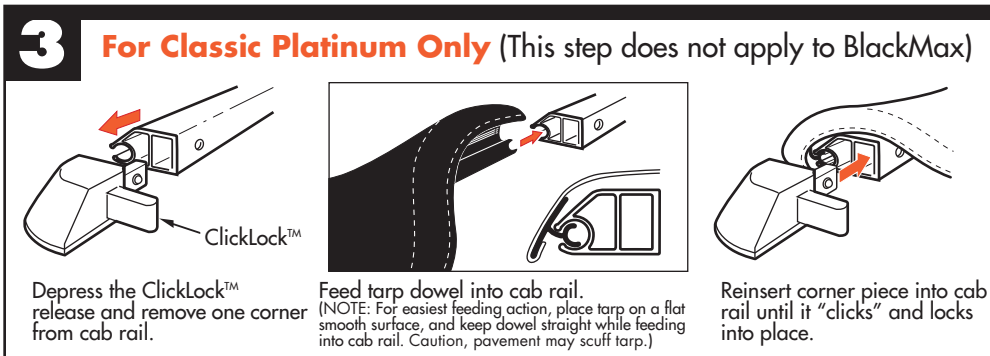

extang
Stands for Quality

Extang Corporation
1901 E. Ellsworth Rd.
Ann Arbor, MI 48108
734 677-0444, Fax: 734 677-8409

Visit us at:
www.extang.com
Item No. 0016-0105 RH Printed in U.S.A.

5

Place the rail assembly over the side of the truck box. Center rails evenly between cab and tailgate.

(NOTE: Some applications have rubber risers (rectangular rubber pads.) A riser must go toward tailgate. Some applications will have a riser at both ends, (most have no riser).

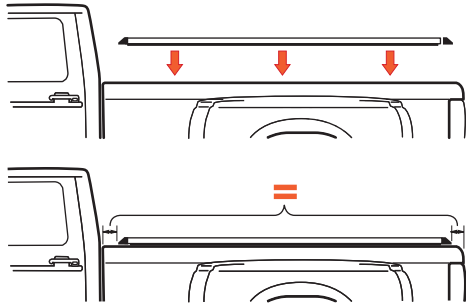

6

Insert side rail clamp all the way into rail.

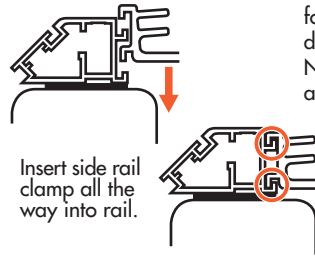

Clamp Spacing (**Same for each side**)
See the stickers located on each side rail for clamp position, or refer to the dimensions given below.
Note: Remove stickers after installation.

Place Clamp Here
STICKER

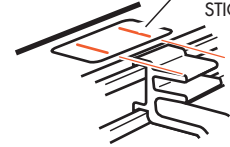

Short Clamp

Short Clamps

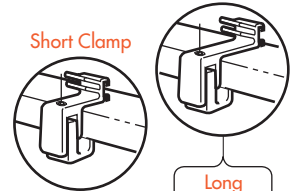

SHORTBED
(3 clamps)

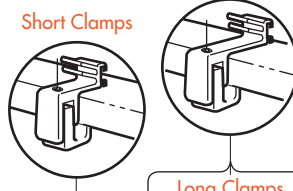

LONGBED
(4 clamps)

Long Clamps

Long Clamps

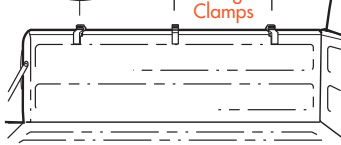

Longer Clamps

Some trucks use different sizes of clamps to fit curved sidewalls. Longer clamps go in the forwardmost (Cab) positions while the shorter clamps hold the rails at the rear (tailgate) end.

FOR INSTALLATION IN THE FOLLOWING TRUCK MODELS:

Ford HD Long-Bed
Ford HD Short-Bed

7

STANDARD CLAMP

IMPORT CLAMP

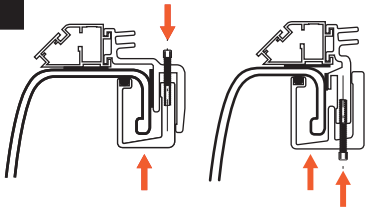

Attach "U" clamp to side rail clamp with allen bolt. Insert side rail clamp all the way into rail.

8

Insert bow onto top or bottom peg.
(Top peg for performance, Bottom for good looks.)

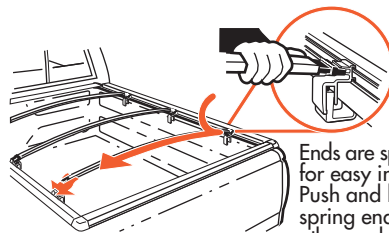

Ends are spring loaded for easy installation. Push and hold on spring end and let the other end slide on with the spring action.

Upper Peg



Lower Peg

SPECIAL FEATURE:
Two pegs offer two height adjustments.



Do Not Place Between the Pegs

Note:
Bow End does not fit between pegs.

9

Start at Corners

Attach tarp by starting at the corners, and snap in place.

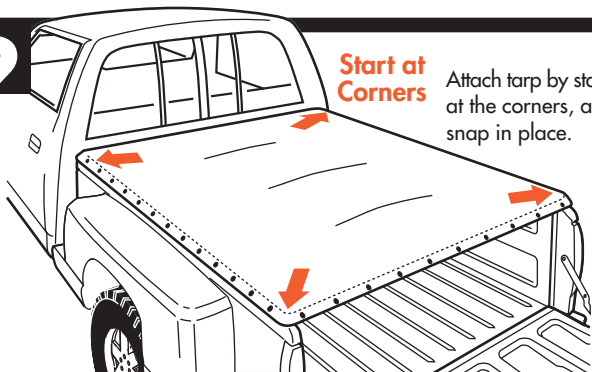

SPECIAL FEATURE
Weather-adjustable Snaps

Studs Down

Slides Off

Rotate 180°

Studs Up

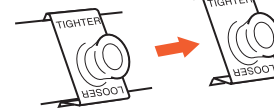

SUMMER SETTING
Takes up slack in tarp caused by warm weather.

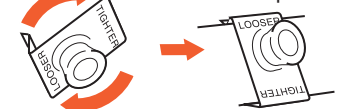

WINTER SETTING
Allows more slack in tarp for cold temperatures.

For an OVER-THE-RAIL Bedliner

DIAGRAM
A

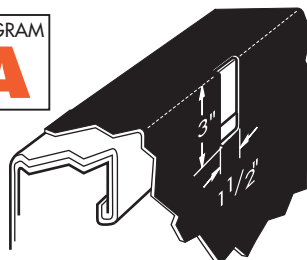
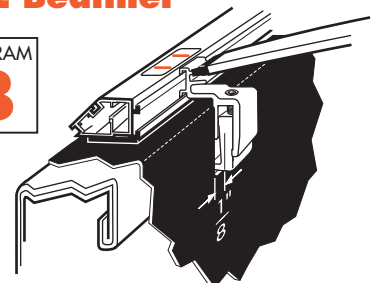

DIAGRAM
B



EASY USE OF TRUCK BED

Tarp may be rolled up and secured with Velcro® for bulk hauling

For each clamp mark on your bedliner a 1-1/2" x 3" hole as shown above. Remove clamp. Cut holes in bedliner. Reinsert side rail clamp. Return to step 6.

Side rail clamped to bed with bow attached.